

**HITANO ENTERPRISE CORP.**  
**Multilayer Ceramic Capacitors**

**APPROVAL SHEET**

**CONTENTS**

<b>Introduction</b>	<b>2</b>
<b>Part Number Code</b>	<b>3</b>
<b>Capacitance Range – NPO</b>	<b>4-5</b>
<b>Capacitance Range – X7R/X5R</b>	<b>6-9</b>
<b>Capacitance Range – Y5V</b>	<b>10</b>
<b>Thickness Code &amp; SPQ</b>	<b>11</b>
<b>Specifications and Test Methods</b>	<b>12-15</b>
<b>Packing</b>	<b>16-19</b>
<b>Soldering &amp; Cleaning</b>	<b>20</b>
<b>Storage and Label</b>	<b>21</b>
<b>PCB Design</b>	<b>22-23</b>

# HITANO ENTERPRISE CORP.

## Multilayer Ceramic Capacitors

### 1. Features

Various temperature characteristics cover a wide range in small size.  
Mounted either by flow or reflow soldering methods  
Excellent dielectric strength due to uniform structure of dielectric layers

### 2. Applications

MLCC are becoming increasingly important key electronic applications, which are helpful in reducing the size of electronic circuitry. MLCC are used extensively in computers, communicative products, and the detail applications which including the followings:  
Discharge of Stored Energy  
Blockage of Direct Current  
Coupling of Circuit Components  
By-Passing of an AC Signal  
Frequency Discrimination  
Transient Voltage and Arc Suppression  
Surge Protection

### 3. Construction of MLCC

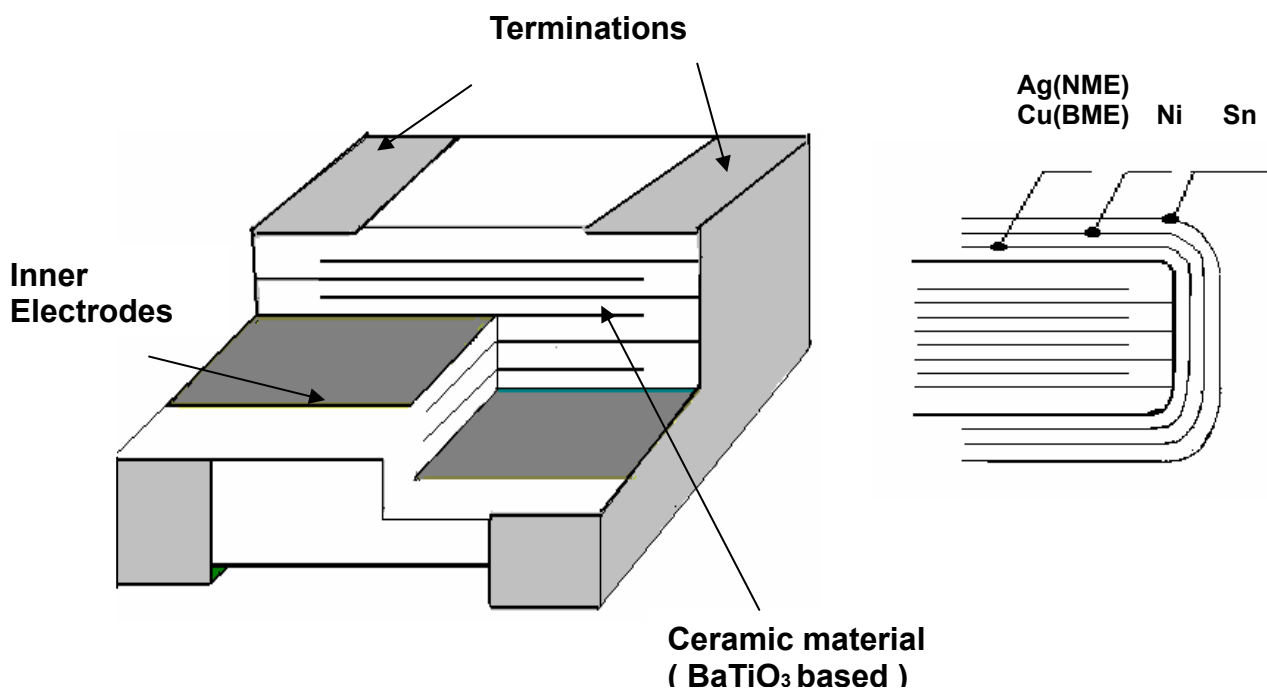

## Part Number Code

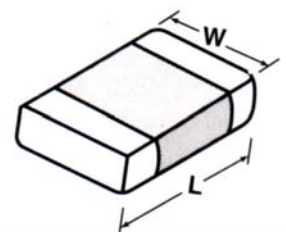
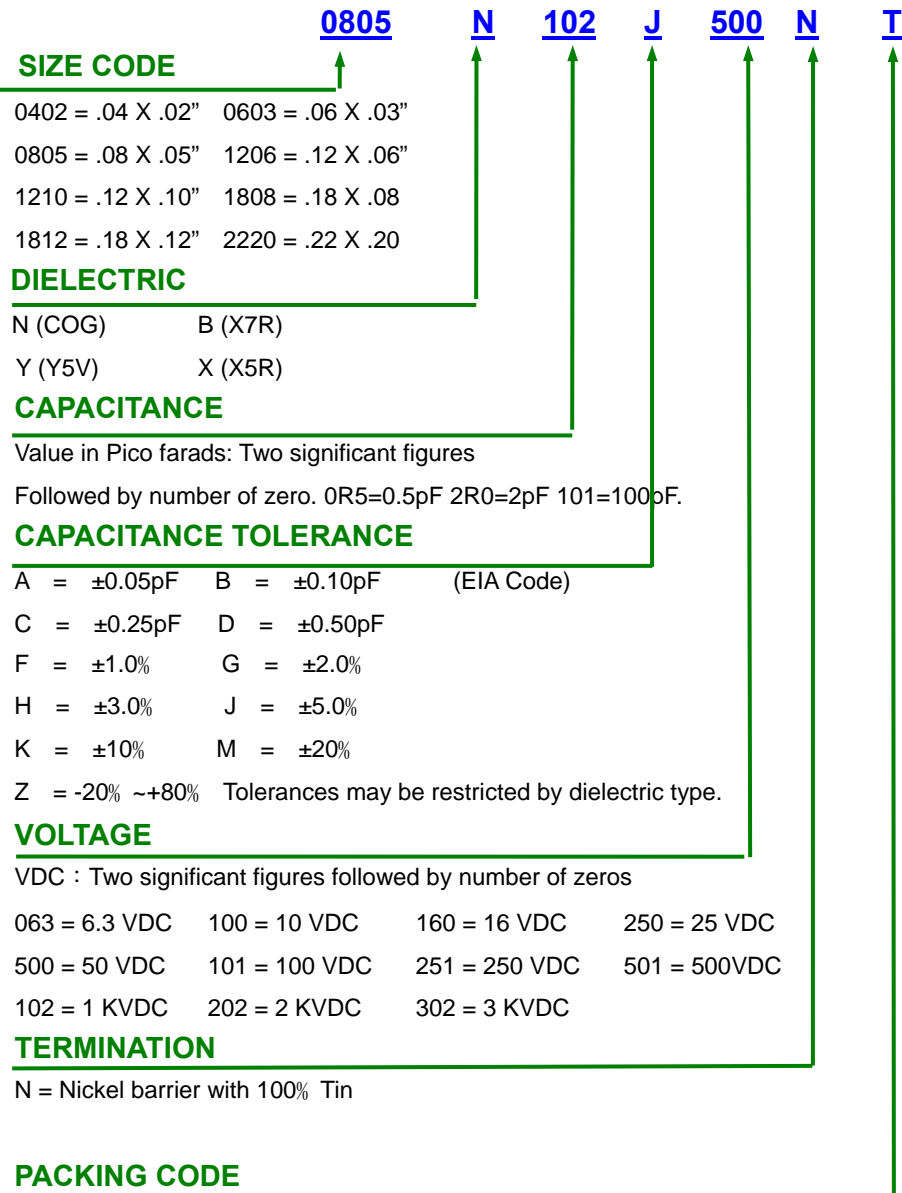

### Dimension : (UNIT mm)

	0402	0603	0805	1206	1210	1808	1812	1825	2220	2211	2225
L	1.00±0.05	1.60±0.10	2.00±0.20	3.20±0.20	3.20±0.30	4.50±0.30	4.50±0.30	4.50±0.30	5.70±0.40	5.70±0.40	5.70±0.40
W	0.50±0.05	0.80±0.10	1.25±0.20	1.60±0.20	2.50±0.20	2.00±0.20	3.20±0.30	6.30±0.40	5.00±0.40	2.80±0.40	6.30±0.40

## 4. Capacitance range NPO

### SIZE AND VALUES AVAILABLE (NPO) 25V – 50V

Size (unit)		0402		0603		0805		1206		1210	1812
(L)Length	mm	1.00±0.05		1.60±0.10		2.00±0.20		3.20±0.20		3.20±0.30	4.50±0.30
(W)Width	mm	0.50±0.05		0.80±0.10		1.25±0.20		1.60±0.20		2.50±0.20	3.20±0.30
(T)Max. Thickness	mm	0.50±0.05		0.80±0.10		1.25±0.10		1.65±0.20		2.50±0.30	3.00±0.30
(t)Terminal	mm	0.15±0.35		0.27~0.60		0.30~0.70		0.30~0.70		0.30~0.70	0.35~1.00
Capacitance W.V.(DC)		25	50	25	50	25	50	25	50	50	50
0.47 – 0.82	pF		S		P		A		H		
1 – 9.1	pF		S		P		A		H		
10	pF		S		P		A		H		
12	pF		S		P		A		H		
15	pF		S		P		A		H		
18	pF		S		P		A		H		
22	pF		S		P		A		H		
27	pF		S		P		A		H		
33	pF		S		P		A		H		
39	pF		S		P		A		H		
47	pF		S		P		A		H		
56	pF		S		P		A		H		
68	pF		S		P		A		H		
82	pF		S		P		A		H		
100	pF		S		P		A		H		
120	pF		S		P		A		H		
150	pF		S		P		A		H		
180	pF		S		P		A		H		
220	pF		S		P		A		H		
270	pF		S		P		A		H		
330	pF	S	S		P		A		H		
390	pF	S	S		P		H		H		
470	pF	S	S		P		H		H		
560	pF	S			P		H		H		
680	pF	S			P		H		H		
820	pF	S			P		H		H		
1.0	nF	S			P		H		H		
1.2	nF				P		H		H		
1.5	nF				P		H		H		
1.8	nF				P		H		H		
2.2	nF				P		H		H		
2.7	nF				P		X		H		
3.3	nF				P		X		H		
3.9	nF			P		A	X		H		
4.7	nF			P		A	X		H		
5.6	nF			P		A	X		H		
6.8	nF			P		A	X		C		
8.2	nF			P		A	X	H	X		
10	nF			P		A	X	H	X		X
15	nF					H		H	X	X	X
22	nF					X		H	X	X	X
33	nF					X		X	L	X	X
47	nF							X		Z	L
68	nF							L		Z	L
100	nF							L		G	Z
220	nF										U

**Capacitance range NPO**

**SIZE AND VALUES AVAILABLE (NPO) 100V – 630V (Medium Voltage)**

Size		0402		0603		0805					1206					1210					1812				
(L)	mm	1.00±0.05		1.60±0.10		2.00±0.20					3.20±0.20					3.20±0.30					4.50±0.30				
(W)	mm	0.50±0.05		0.80±0.10		1.25±0.20					1.60±0.20					2.50±0.20					3.20±0.30				
(T)	mm	0.50±0.05		0.80±0.10		1.25±0.10					1.65±0.20					2.50±0.30					3.00±0.30				
(t)	mm	0.15±0.35		0.27~0.60		0.30~0.70					0.30~0.70					0.30~0.70					0.35~1.00				
Cap./ W.V.		100	100	200	250	100	200	250	500	630	100	200	250	500	630	100	200	250	500	630	100	200	250	500	630
10	pF	S	P	P	P	A	A	A	A	A	H	H	H	H	H	C	C	C	C	C	X	X	X	X	X
12	pF	S	P	P	P	A	A	A	A	A	H	H	H	H	H	C	C	C	C	C	X	X	X	X	X
15	pF	S	P	P	P	A	A	A	A	A	H	H	H	H	H	C	C	C	C	C	X	X	X	X	X
18	pF	S	P	P	P	A	A	A	A	A	H	H	H	H	H	C	C	C	C	C	X	X	X	X	X
22	pF	S	P	P	P	A	A	A	A	A	H	H	H	H	H	C	C	C	C	C	X	X	X	X	X
27	pF	S	P	P	P	A	A	A	A	A	H	H	H	H	H	C	C	C	C	C	X	X	X	X	X
33	pF	S	P	P	P	A	A	A	A	A	H	H	H	H	H	C	C	C	C	C	X	X	X	X	X
39	pF	S	P	P	P	A	A	A	A	A	H	H	H	H	H	C	C	C	C	C	X	X	X	X	X
47	pF	S	P	P	P	A	A	A	A	A	H	H	H	H	H	C	C	C	C	C	X	X	X	X	X
56	pF	S	P	P	P	A	A	A	A	A	H	H	H	H	H	C	C	C	C	C	X	X	X	X	X
68	pF	S	P	P	P	A	A	A	A	A	H	H	H	H	H	C	C	C	C	C	X	X	X	X	X
82	pF	S	P	P	P	A	A	A	H	H	H	H	H	H	H	C	C	C	C	C	X	X	X	X	X
100	pF	S	P	P	P	A	A	H	H	H	H	H	H	H	H	C	C	C	C	C	X	X	X	X	X
120	pF	S	P	P	P	A	A	H	X	X	H	H	H	H	H	C	C	C	C	C	X	X	X	X	X
150	pF	S	P	P	P	A	H	X	X	X	H	H	H	H	H	C	C	C	C	C	X	X	X	X	X
180	pF	S	P	P	P	A	H	X	X	X	H	H	H	H	H	C	C	C	C	C	X	X	X	X	X
220	pF	S	P	P	P	A	X	X	X	X	H	H	H	H	H	C	C	C	C	C	X	X	X	X	X
270	pF		P			A	X	X	X	X	H	H	C	C	C	C	C	C	C	C	X	X	X	X	X
330	pF		P			A	X	X	X	X	H	H	C	C	C	C	C	C	C	C	X	X	X	X	X
390	pF		P			H	X	X	X	X	H	H	C	C	C	C	C	C	C	C	X	X	X	X	X
470	pF		P			H	X	X			H	C	C	C	C	C	C	C	C	C	X	X	X	X	X
560	pF		P			H	X	X			H	C	X	X	X	C	C	C	C	C	X	X	X	X	X
680	pF		P			H	X	X			H	C	X	X	X	C	C	C	C	C	X	X	X	X	X
820	pF		P			H	X	X			H	C	L	L	L	C	C	C	C	C	X	X	X	X	X
1000	pF		P			H	X				H	C	L	L	L	C	X	X	X	X	X	X	X	X	X
1200	pF					H					H	C	L	L	L	C	X	X	X	X	X	X	X	X	X
1500	pF					H					H	X	L	L	L	C	X	X	X	X	X	X	X	X	X
1800	pF					H					H	X	L	L	L	C	X	X	X	X	X	X	X	X	X
2200	pF					H					H	X	L	L	L	C	X	X	X	X	X	X	X	X	X
2700	pF					X					H					C	X	X	X	X	X	X	X	X	X
3300	pF					X					H					C	X	X	X	X	X	X	X	X	X
3900	pF					X					H					C	X	X			X	X	X	X	X
4700	pF					X					H					C	X	X			X	X	X	X	X
5600	pF										H					C	X	X			X	X	X	X	X
6800	pF										C					C					X	X	X		
8200	pF										X					C					X	X	X		
10	nF										X					C					X	X	X		
15	nF															X					X				
22	nF																				X				
33	nF																				X				

Remark: Customized size and specification is available upon request. Please contact us for further details

## Capacitance range NPO

### SIZE AND VALUES AVAILABLE (NPO) 1000V – 6000V (High Voltage)

Size	0805	1206			1210			1808			1812			2220		2211		
(L)	mm	2.00±0.20	3.20±0.20			3.20±0.30			4.50±0.30			4.50±0.30			5.70±0.40		5.70±0.40	
(W)	mm	1.25±0.20	1.60±0.20			2.50±0.20			2.00±0.20			3.20±0.30			5.00±0.40		2.80±0.40	
(T)	mm	1.25±0.10	1.65±0.20			2.50±0.30			2.00±0.20			3.00±0.30			3.00±0.20		3.00±0.20	
(t)	mm	0.30~0.70	0.30~0.70			0.30~0.70			0.35~1.00			0.35~1.00			0.35~1.00		0.35~1.00	
Cap./mm		1000	1000	2000	3000	1000	2000	3000	1000	2000	3000	1000	2000	3000	1000	5000	5000	6000
1~10	pF	H	H	H	L	C	C	L	X	X	X	X	X	X		Z	Z	Z
12	pF	H	H	H	L	C	C	L	X	X	X	X	X	X		Z	Z	Z
15	pF	H	H	H	L	C	C	L	X	X	X	X	X	X		Z	Z	Z
18	pF	H	H	H	L	C	C	L	X	X	X	X	X	X		Z	Z	Z
22	pF	H	H	H		C	C	L	X	X	X	X	X	X		Z	Z	Z
27	pF	H	H	H		C	C	L	X	X	X	X	X	X		Z	Z	Z
33	pF	H	H	C		C	C	L	X	X	X	X	X	X		Z	Z	Z
39	pF	H	H	C		C	X	L	X	X	X	X	X	X		Z	Z	Z
47	pF	H	C	C		C	X	L	X	X	X	X	X	X		Z	Z	Z
56	pF	H	C	X		C	X	L	X	X	X	X	X	X		Z	Z	Z
68	pF		C	X		C	X	L	X	X	X	X	X	X		Z	Z	Z
82	pF		X	X		C	X	L	X	X	X	X	X	X		Z	Z	Z
100	pF		X	X		X	X	L	X	X	Z	X	X	X	X	Z	Z	Z
120	pF		X	L		X	X	L	X	X	Z	X	X	X	X	Z		
150	pF		X	L		X	L	L	X	Z	Z	X	X	X	X	Z		
180	pF		X	L		X	L	L	X	Z	Z	X	X	Z	X			
220	pF		X	L		L	L	L	X	Z	Z	X	X	Z	X			
270	pF		X	L		L	L		Z	Z	Z	X	Z	Z	X			
330	pF		X			L	L		Z	Z	Z	X	Z	Z	X			
390	pF		X			L	L		Z	Z		X	Z	Z	X			
470	pF		X			L	L		Z	Z		Z	Z	Z	X			
560	pF		X			L	L		Z	Z		Z	Z		X			
680	pF		L			L			Z	Z		Z	Z		X			
820	pF		L			L			Z			Z	Z		X			
1000	pF		L			L			Z			Z	Z		X			
1200	pF								Z			Z			X			
1500	PF											Z			X			
1800	PF											Z			L			
2200	pF											Z			L			
2700	pF											Z			Z			
3300	pF											Z			Z			
3900	pF											Z			Z			
4700	pF											Z			Z			
5600	pF											Z			Z			
6800	pF											G			Z			
8200	pF														Z			
10000	pF														Z			
12000	pF														Z			
15000	pF														G			
18000	pF														G			

Remark: Customized size and specification is available upon request. Please contact us for further details

## 5. Capacitance range X7R/X5R

### SIZE AND VALUES AVAILABLE (X7R) 10V – 50V

Size	0402			0603				0805				1206				1210			1812		2220		
(L)	mm	1.00±0.05			1.60±0.10				2.00±0.20				3.20±0.20				3.20±0.30			4.50±0.3		5.70±0.40	
(W)	mm	0.50±0.05			0.80±0.10				1.25±0.20				1.60±0.20				2.50±0.20			3.20±0.2		5.00±0.40	
(T)	mm	0.50±0.05			0.80±0.12				1.25±0.20				1.65±0.20				2.50±0.20			3.00±0.2		3.00±0.20	
(t)	mm	0.15~0.35			0.27~0.60				0.30~0.70				0.30~0.70				0.30~0.70			0.35~1.0		0.35~1.00	
Cap. \ W.V.	10	16/25	50	10	16	25	50	10	16	25	50	10	16	25	50	16	25	50	25	50	25	50	
100	pF		S				P				H												
120	pF		S				P				H												
150	pF		S				P				H												
180	pF		S				P				H												
220	pF		S				P				H				H								
270	pF		S				P				H				H								
330	pF		S				P				H				H								
390	pF		S				P				H				H								
470	pF		S				P				H				H								
560	pF		S				P				H				H								
680	pF		S				P				H				H								
820	pF		S				P				H				H								
1000	pF		S				P				H				H								
1200	pF		S				P				H				H								
1500	pF		S				P				H				H								
1800	pF		S				P				H				H								
2200	pF		S				P				H				H								
2700	pF		S				P				H				H								
3300	pF		S				P				H				H								
3900	pF		S				P				H				H								
4700	pF		S				P				H				H								
5600	pF		S				P				H				H								
6800	pF		S				P				H				H								
8200	pF		S				P				H				H								
10	nF		S	S			P				H				H								
12	nF		S				P				H				H								
15	nF		S				P				H				H								
18	nF		S				P				H				H								
22	nF		S	S			P				H				H								
27	nF						P				H				H								
33	nF		S				P				H				H								
39	nF						P				H				H								
47	nF		S	S			P	P			H				H								
56	nF						P	P			H				H								
68	nF		S				P	P			H				H								
82	nF						P	P			H				H								
100	nF	S	S	S		P	P	P			H				H						X		
150	nF				P	P	P		X	X	X				X						X		
220	nF	S			P	P	P		X	X	X				X						X		
330	nF				P	P	P		X	X	X			X	X						X		
470	nF				P	P	P		X	X	X			X	L						X		
680	nF				P	P			X	X			X	X	L						X		
1.0	uF				P	P	P		X	X	X	X		X	X	L		L			X	Z	
2.2	uF								X	X	X			L	L	L			Z		Z	Z	
3.3	uF																L	G			Z	Z	
4.7	uF											L	L	L	L		Z		L	Z	Z	Z	
10	uF											L	L			Z	Z/G		Z/G		Z		
22	uF															G			Z/G		G		

**Capacitance range X7R**

**SIZE AND VALUES AVAILABLE (X7R) 100V – 630V (Medium Voltage)**

Size		0603			0805				1206					1210					1812				
(L)	mm	1.60±0.10			2.00±0.20				3.20±0.20					3.20±0.30					4.50±0.30				
(W)	mm	0.80±0.10			1.25±0.20				1.60±0.20					2.50±0.20					3.20±0.20				
(T)	mm	0.80±0.12			1.25±0.20				1.65±0.20					2.50±0.20					2.50±0.20				
(t)	mm	0.27~0.60			0.30~0.70				0.30~0.70					0.30~0.70					0.35~1.00				
Cap. \ W.V.		100	200	250	100	200	250	500	100	200	250	500	630	100	200	250	500	630	100	200	250	500	630
100	pF	P	P	P	H	H	H	H	H	H													
150	pF	P	P	P	H	H	H	H	H	H													
220	pF	P	P	P	H	H	H	H	H	H	X	X											
330	pF	P	P	P	H	H	H	H	H	H	X	X											
470	pF	P	P	P	H	H	H	H	H	H	X	X							L	L	L	L	L
680	pF	P	P	P	H	H	H	H	H	H	X	X							L	L	L	L	L
1000	pF	P	P	P	H	H	H	H	H	H	X	X							L	L	L	L	L
1500	pF	P	P	P	H	H	H	H	H	H	X	X							L	L	L	L	L
2200	pF	P	P	P	H	H	H	H	H	H	X	X							L	L	L	L	L
3300	pF	P	P	P	H	H	H	H	H	H	X	X							L	L	L	L	L
4700	pF	P	P	P	H	H	H	X	H	H	X	X							L	L	L	L	L
6800	pF	P	P	P	H	H	H	X	H	H	X	X							L	L	L	L	L
10	nF	P	P	P	H	H	H	X	H	H	X	X		L	L	L	L	L	L	L	L	L	L
15	nF	P			H	H	H	X	H	X	X	L	L		L	L	L	L	L	L	L	L	L
22	nF	P			H	H	H	X	H	X	X	L	L		L	L	L	L	L	L	L	L	L
33	nF	P			X	X	X		X	X	X	L	L		L	L	L	L	L	L	L	L	L
47	nF				X				X	X	X				L	L	L	L	L	L	L	L	L
68	nF				X				X	L	L				L	L			L	L	L	L	Z
100	nF				X				X	L	L			L	L	L			L	L	L	L	Z
150	nF								L					L	L	L			L	L	L		
220	nF								L					L	L	L			L	L	L		
330	nF								L					L	G	G			L	L	Z		
470	nF								L					L	G	G			L	L	Z		
680	nF								L					L					L	G	G		
1.0	uF								L					Z					L	G	G		
1.5	uF													G					L				
2.2	uF													G					G				



**SIZE AND VALUES AVAILABLE (X7R) 100V – 630V (Medium Voltage)**

Size		1825					2220					2225				
(L)	mm	4.50±0.30					5.70±0.40					5.70±0.40				
(W)	mm	6.30±0.40					5.00±0.40					6.30±0.40				
(T)	mm	2.50±0.30					3.00±0.20					3.00±0.20				
(t)	mm	0.35~1.00					0.35~1.00					0.35~1.00				
Cap. \\W.V		100	200	250	500	630	100	200	250	500	630	100	200	250	500	630
470	pF															
680	pF															
1000	pF	Z	Z	Z	Z	Z	Z	Z	Z	Z	Z	Z	Z	Z	Z	Z
1500	pF	Z	Z	Z	Z	Z	Z	Z	Z	Z	Z	Z	Z	Z	Z	Z
2200	pF	Z	Z	Z	Z	Z	Z	Z	Z	Z	Z	Z	Z	Z	Z	Z
3300	pF	Z	Z	Z	Z	Z	Z	Z	Z	Z	Z	Z	Z	Z	Z	Z
4700	pF	Z	Z	Z	Z	Z	Z	Z	Z	Z	Z	Z	Z	Z	Z	Z
6800	nF	Z	Z	Z	Z	Z	Z	Z	Z	Z	Z	Z	Z	Z	Z	Z
10	nF	Z	Z	Z	Z	Z	Z	Z	Z	Z	Z	Z	Z	Z	Z	Z
15	nF	Z	Z	Z	Z	Z	Z	Z	Z	Z	Z	Z	Z	Z	Z	Z
22	nF	Z	Z	Z	Z	Z	Z	Z	Z	Z	Z	Z	Z	Z	Z	Z
33	nF	Z	Z	Z	Z	Z	Z	Z	Z	Z	Z	Z	Z	Z	Z	Z
47	nF	Z	Z	Z	Z	Z	Z	Z	Z	Z	Z	Z	Z	Z	Z	Z
68	nF	Z	Z	Z	Z	Z	Z	Z	Z	Z	Z	Z	Z	Z	Z	Z
100	nF	Z	Z	Z	Z	Z	Z	Z	Z	Z	Z	Z	Z	Z	Z	Z
150	nF	Z	Z	Z	Z	Z	Z	Z	Z	Z	Z	Z	Z	Z	Z	Z
220	nF	Z	Z	Z	Z	Z	Z	Z	Z	Z	Z	Z	Z	Z	Z	Z
330	nF	Z	Z	Z			Z	Z	Z			Z	Z	Z	Z	Z
470	nF	Z	Z	Z			Z	Z	Z			Z	Z	Z	G	G
680	nF	Z	Z	Z			Z	Z	Z			Z	Z	Z		
1.0	uF	Z	Z	Z			Z	Z	Z			Z	Z	Z		
2.2	uF	Z	G	G			Z	G	G			Z	G	G		
3.3	uF	Z					Z					Z				
4.7	uF	G					G					G				

Remark: Customized size and specification is available upon request. Please contact us for further details

**SIZE AND VALUES AVAILABLE (X7R) 1000V – 6000V (High Voltage)**

Size		1206		1210		1808			1812			1825			2220			2211			2225										
(L)	mm	3.20±0.30		4.50±0.30		4.50±0.30			4.50±0.30			5.70±0.40			4.50±0.30			5.70±0.40			5.70±0.40										
(W)	mm	2.50±0.20		2.00±0.20		3.20±0.20			6.30±0.40			5.00±0.40			3.20±0.20			6.30±0.40			6.30±0.40										
(T)	mm	2.50±0.20		2.00±0.20		3.00±0.20			2.50±0.30			3.00±0.20			3.00±0.20			3.00±0.20			3.00±0.20										
(t)	mm	0.30~0.70		0.35~1.00		0.35~1.00			0.35~1.00			0.35~1.00			0.35~1.00			0.35~1.00			0.35~1.00										
Cap. \ W.V.		1000		2000		1000		2000		3000		1000		2000		3000		1000		2000		3000		4000		1000		2000		3000	
100	pF	X	X	L	L				L	L	L																				
120	pF	X	X	L	L				L	L	L																				
150	pF	X	X	L	L	L	L	L	L	L	L													L							
180	pF	X	X	L	L	L	L	L	L	L	L													L							
220	pF	X	X	L	L	L	L	L	L	L	L													L							
270	pF	X	X	L	L	L	L	L	L	L	L													L							
330	pF	X	X	L	L	L	L	L	L	L	L													L							
390	pF	X	X	L	L	L	L	L	L	L	L													L							
470	pF	X	X	L	L	L	L	L	L	L	L				Z									L							
560	pF	X	X	L	L	L	L	Z	L	L	L				Z									L							
680	pF	X	X	L	L	L	L	Z	L	L	L				Z									L							
820	pF	X	X	L	L	L	L	Z	L	L	L				Z									Z							
1000	pF	X	X/L	L	L	L	L	Z	L	L	L	Z	Z	Z	Z	Z	Z	Z	Z	Z	Z	Z	Z	Z	Z	Z	Z	Z	Z		
1200	pF	X/L	L	L	L	L	L	Z	L	L	L	Z	Z	Z	Z	Z	Z	Z	Z	Z	Z	Z	Z	Z	Z	Z	Z	Z	Z		
1500	pF	X/L	L	L	L	L	L	Z	L	L	L	Z	Z	Z	Z	Z	Z	Z	Z	Z	Z	Z	Z	G	Z	Z	Z	Z	Z		
1800	pF	X/L		L	Z	L	L	Z	L	L	Z	Z	Z	Z	Z	Z	Z	Z	Z	Z	Z	Z	Z	G	Z	Z	Z	Z	Z		
2200	pF	X/L		L	Z	L	Z		L	L	Z	Z	Z	Z	Z	Z	Z	Z	Z	Z	Z	Z	Z	G	Z	Z	Z	Z	Z		
2700	pF	X/L		L		L	Z		L	L	Z	Z	Z	Z	Z	Z	Z	Z	Z	Z	Z	Z	Z		Z	Z	Z	Z	Z		
3300	pF	X/L		L		L	Z		L	Z		Z	Z	Z	Z	Z	Z	Z	Z	Z	Z	Z	Z		Z	Z	Z	Z	Z		
3900	pF	X/L		L		L			L	Z		Z	Z	Z	Z	Z	Z	Z	Z	Z	Z	Z	Z		Z	Z	Z	Z	Z		
4700	pF	X/L		L		L			L	Z		Z	Z		Z	Z	G							Z	Z	G					
5600	pF	X/L		L		L			L	Z		Z	Z		Z	Z								Z	Z	G					
6800	pF	X/L		L		L			L	Z		Z	Z		Z	Z								Z	Z	G					
8200	pF	X/L		L		L			L	Z		Z			Z	Z								Z	Z						
10	nF	X/L		L		L			Z	Z		Z			Z	Z								Z	Z						
12	nF								Z			Z			Z									Z	Z						
15	nF								Z			Z			Z									Z							
18	nF								G			Z			Z									Z							
22	nF								G			Z			Z									Z							
27	nF								G			Z			Z									Z							
33	nF								G			Z			Z									Z							
39	nF								G			Z			Z									Z							
47	nF								G			Z			Z									Z							
56	nF								G			Z			Z									Z							
68	nF											Z			Z									Z							
82	nF											G			Z									Z							
100	nF											G												Z							

**SIZE AND VALUES AVAILABLE (X5R) 6.3V – 50V \*Available in 20% tolerance only.**

Size	0402		0603			0805				1206				1210					1812				2220			
(L)	mm	1.00±0.05	1.60±0.10			2.00±0.20				3.20±0.20				3.20±0.30					4.50±0.30				5.70±0.40			
(W)	mm	0.50±0.05	0.80±0.10			1.25±0.20				1.60±0.20				2.50±0.20					3.20±0.30				5.00±0.40			
(T)	mm	0.50±0.05	0.80±0.12			1.25±0.20				1.65±0.20				2.50±0.20					3.20±0.20				3.00±0.20			
(t)	mm	0.15~0.35	0.27~0.60			0.30~0.70				0.30~0.70				0.30~0.70					0.35~1.00				0.35~1.00			
Cap./ W.V.		6.3	10	6.3	10	16	6.3	10	16	25	6.3	10	16	25	6.3	10	16	25	50	6.3	10	16	25	16	25	50
100	nF		S																							
220	nF	S	S																							
330	nF	S																								
470	nF	S	S		P																					
680	nF	S			P																					
1.0	uF	S	S		P	P				X	H/X															
2.2	uF	S			P	P	P	X	X	X	H/X															
3.3	uF							X	X																	
4.7	uF				P	P		X	X	X	H/X			L	L				Z	Z						
10	uF				*P			H/X	X	X		L	L	L	L			Z	Z	Z			Z/G		Z	G
22	uF							*X	*X			L	L	*L			Z/G	Z/G	G			G	G		G	
47	uF							*X				*L	*L			*G	*G				*G				*G	
100	uF															*G					*U					

**6. Capacitance range Y5V**

**SIZE AND VALUES AVAILABLE (Y5V)**

Size	0402		0603				0805					1206					1210				1812						
(L)	mm	1.00±0.05	1.600±0.10				2.00±0.20					3.20±0.20					3.20±0.30				4.50±0.30						
(W)	mm	0.50±0.05	0.80±0.10				1.25±0.20					1.60±0.20					2.50±0.20				3.20±0.30						
(T)	mm	0.50±0.05	0.80±0.12				1.25±0.20					1.65±0.20					2.00±0.20				2.50±0.20						
(t)	mm	0.15~0.35	0.27~0.60				0.30~0.70					0.30~0.70					0.30~0.70				0.35~1.00						
Cap./ W.V.		6.3	10	16	6.3	10	16	25	50	6.3	10	16	25	50	6.3	10	16	25	50	6.3	10	16	25	10	16	25	50
10	nF			S					P					A					H								
15	nF			S					P					A					H								
22	nF			S					P					A					H								
33	nF			S					P					A					H								
47	nF			S					P					A					H								
68	nF			S					P					A					H								
100	nF			S					P					A	A				H								
150	nF							P	P					A	A				H								
220	nF		S				P	P	P					A	A				H								
330	nF		S				P	P						H	H				H								
470	nF	S	S			P	P	P						H	H	H			H								
680	nF	S				P	P							X	X	X			H	X							
1.0	uF	S				P	P							X	X	X			X	X							
2.2	uF				P	P								X	X	X			X	X	X						
3.3	uF				P									X	X				X	X							
4.7	uF				P									X	X				X	X							
10	uF									X	X							X	X			Z	X	L			G
22	uF									X					L	L					Z	Z				G	
47	uF													L						Z	Z				G		
100	uF																			G					G		

## Thickness Code & Standard Packing Q'ty per reel

Thickness Code	Chip Size	Chip Thickness	Max Tape Thickness	Q'ty of carboard tape in		Q'ty of Embosses tape in	
				7" reel	13" reel	7" reel	13" reel
S	0402	0.50±0.05 mm	0.60 mm	10,000	50,000	--	--
P	0603	0.80±0.10 mm	0.95 mm	4,000	15,000	--	--
A	0805	0.60±0.10 mm	0.75 mm	4,000	15,000	--	--
H		0.85±0.10 mm	0.95 mm	4,000	15,000	--	--
X		1.25±0.10 mm	1.80 mm	--	--	3,000	10,000
H	1206	0.85±0.10 mm	0.90 mm	4,000	15,000	--	--
C		0.95±0.10 mm	1.80 mm			3,000	10,000
X		1.25±0.10 mm	1.80 mm	--	--	3,000	10,000
L		1.65±0.20 mm	1.80 mm	--	--	2,000	--
C	1210	0.95±0.10 mm	1.80 mm			3,000	10,000
X		1.25±0.10 mm	1.80 mm	--	--	2,000	--
L		1.65±0.20 mm	1.80 mm	--	--	2,000	--
Z		2.00±0.20 mm	2.20 mm	--	--	2,000	--
G		2.50±0.20 mm	2.75 mm	--	--	1,000	--
X	1808	1.25±0.10 mm	1.80 mm	--	--	2,000	--
F		1.40±0.20 mm	1.80 mm	--	--	2,000	--
L		1.65±0.20 mm	1.80 mm	--	--	2,000	--
Z		2.00±0.20 mm	2.20 mm	--	--	1,000	--
X	1812	1.25±0.20 mm	1.80 mm	--	--	1,000	--
L		1.65±0.20 mm	1.80 mm			1,000	
Z		2.00±0.20 mm	2.20 mm	--	--	1,000	--
G		2.50±0.20 mm	2.75 mm	--	--	500	--
Z	1825	2.00±0.20 mm	2.20 mm	--	--	1,000	--
G		2.50±0.20 mm	2.75 mm	--	--	500	--
Z	2220	2.00±0.20 mm	2.20 mm	--	--	500	--
G		2.50±0.20 mm	2.75 mm	--	--	500	--
L	2211	1.65±0.20 mm	1.80 mm			1,000	
Z		2.00±0.20 mm	2.20 mm	--	--	1,000	--
G		2.50±0.20 mm	2.75 mm	--	--	500	--
Z	2225	2.00±0.20 mm	2.20 mm	--	--	1,000	--
G		2.50±0.20 mm	2.75 mm	--	--	500	--

## 1. SPECIFICATIONS AND TEST METHODS

No	Item	Test Method	Specification																																		
1	Capacitance	<p>The capacitance shall be measured at 25°C at the frequency and voltage shown below:</p> <table border="1"> <tr> <td>Type</td> <td>NPO (≤1nF)</td> <td>NPO&gt;1nF, Y5V, X7R/X5R</td> <td>C ≥ 10uF</td> </tr> <tr> <td>Freq.</td> <td>1±0.1Mhz</td> <td>1±0.1KHz</td> <td>120H</td> </tr> <tr> <td>Voltage</td> <td>1±0.2Vrms</td> <td>1±0.2Vrms</td> <td>0.5±0.2 Vrms</td> </tr> </table>	Type	NPO (≤1nF)	NPO>1nF, Y5V, X7R/X5R	C ≥ 10uF	Freq.	1±0.1Mhz	1±0.1KHz	120H	Voltage	1±0.2Vrms	1±0.2Vrms	0.5±0.2 Vrms	<p>Within the specified tolerance</p> <p><b>Remark: For ClassII(X7R/X5R,Y5V), Before initial test, please perform De-aging process as below:</b></p> <p><b>Heat up to 150°C for 1Hr and then set form 48±4 Hrs at room temp.</b></p>																						
Type	NPO (≤1nF)	NPO>1nF, Y5V, X7R/X5R	C ≥ 10uF																																		
Freq.	1±0.1Mhz	1±0.1KHz	120H																																		
Voltage	1±0.2Vrms	1±0.2Vrms	0.5±0.2 Vrms																																		
2	Q value / Dissipation Factor	<p>D.F. shall be measured at 25°C at the frequency and voltage shown a o. 1</p> <p style="text-align: center;">EXCEPTION OF D.F.</p> <p><b>X7R/X5R</b></p> <table border="1"> <thead> <tr> <th>r</th> <th>D.F</th> <th>Exc ption of D F.</th> </tr> </thead> <tbody> <tr> <td rowspan="2">≥ 50V</td> <td>≤ 3.5%</td> <td>0603 ≥ 47nF, 0805 ≥ 0.18uF, 1206 ≥ 0.47uF, 1210 ≥ 1.0uF</td> </tr> <tr> <td>≤ 5%</td> <td>0805 ≥ 1.0uF, 1210 ≥ 10uF</td> </tr> <tr> <td rowspan="3">25V</td> <td>≤ 7%</td> <td>0603 ≥ 0.33uF, 1206 ≥ 4.7uF</td> </tr> <tr> <td>≤ 10%</td> <td>0603 ≥ 0.47uF, 0805 ≥ 2.2uF, 1206 ≥ 6.8uF, 0402 ≥ 0.1uF</td> </tr> <tr> <td>≤ 5%</td> <td>0402 ≥ 33nF, 0603 ≥ 0.15uF, 0805 ≥ 0.68uF, 1206 ≥ 2.2uF, 1210 ≥ 4.7uF,</td> </tr> <tr> <td rowspan="2">16V</td> <td>≤ 10%</td> <td>0603 ≥ 0.68uF, 0805 ≥ 2.2uF, 1206 ≥ 4.7uF, 1210 ≥ 22uF,</td> </tr> <tr> <td>≤ 10%</td> <td>0402 &amp; 0603 ≥ 0.33uF, 0805 ≥ 2.2uF, 1206 ≥ 2.2uF, 1210 ≥ 22uF</td> </tr> </tbody> </table> <p><b>Y5V</b></p> <table border="1"> <thead> <tr> <th>Vr</th> <th>D.F</th> <th>Exception o .F.</th> </tr> </thead> <tbody> <tr> <td>≥ 50V</td> <td>≤ 7%</td> <td>0603 ≥ 0.1uF, 0805 ≥ 0.47uF, 1206 ≥ 4.7uF</td> </tr> <tr> <td rowspan="2">25V</td> <td>≤ 9%</td> <td>0402 ≥ 47nF, 0805 ≥ 0.47uF</td> </tr> <tr> <td>≤ 12.5%</td> <td>121 /10uF</td> </tr> <tr> <td>16V</td> <td>≤ 9%</td> <td>0402 ≥ 0.068uF, 0603 ≥ 0.68uF</td> </tr> </tbody> </table>	r	D.F	Exc ption of D F.	≥ 50V	≤ 3.5%	0603 ≥ 47nF, 0805 ≥ 0.18uF, 1206 ≥ 0.47uF, 1210 ≥ 1.0uF	≤ 5%	0805 ≥ 1.0uF, 1210 ≥ 10uF	25V	≤ 7%	0603 ≥ 0.33uF, 1206 ≥ 4.7uF	≤ 10%	0603 ≥ 0.47uF, 0805 ≥ 2.2uF, 1206 ≥ 6.8uF, 0402 ≥ 0.1uF	≤ 5%	0402 ≥ 33nF, 0603 ≥ 0.15uF, 0805 ≥ 0.68uF, 1206 ≥ 2.2uF, 1210 ≥ 4.7uF,	16V	≤ 10%	0603 ≥ 0.68uF, 0805 ≥ 2.2uF, 1206 ≥ 4.7uF, 1210 ≥ 22uF,	≤ 10%	0402 & 0603 ≥ 0.33uF, 0805 ≥ 2.2uF, 1206 ≥ 2.2uF, 1210 ≥ 22uF	Vr	D.F	Exception o .F.	≥ 50V	≤ 7%	0603 ≥ 0.1uF, 0805 ≥ 0.47uF, 1206 ≥ 4.7uF	25V	≤ 9%	0402 ≥ 47nF, 0805 ≥ 0.47uF	≤ 12.5%	121 /10uF	16V	≤ 9%	0402 ≥ 0.068uF, 0603 ≥ 0.68uF	<p><b>NPO:</b> C &lt; 30pF : Q value ≥ 400+20C C ≥ 30pF : Q value ≥ 1000</p> <p><b>X7R/ X5R :</b> Vr=50V~6KV, DF ≤ 2.5% Vr=25V, DF ≤ 3.5% Vr=16V, DF ≤ 3.5% Vr=10V, DF ≤ 5.0% Vr=6.3V, DF ≤ 10.0%</p> <p><b>Y5V:</b> Vr= ≥ 50V, DF ≤ 5.0% Vr =25V, DF ≤ 7.0% Vr=16V(C &lt; 1.0uF), DF ≤ 7.0% Vr=16V(C ≥ 1.0uF), DF ≤ 9.0% Vr=10V, DF ≤ 12.5% Vr=6.3V, DF ≤ 20%</p> <p><b>( see EXCEPTION at left side)</b></p>
r	D.F	Exc ption of D F.																																			
≥ 50V	≤ 3.5%	0603 ≥ 47nF, 0805 ≥ 0.18uF, 1206 ≥ 0.47uF, 1210 ≥ 1.0uF																																			
	≤ 5%	0805 ≥ 1.0uF, 1210 ≥ 10uF																																			
25V	≤ 7%	0603 ≥ 0.33uF, 1206 ≥ 4.7uF																																			
	≤ 10%	0603 ≥ 0.47uF, 0805 ≥ 2.2uF, 1206 ≥ 6.8uF, 0402 ≥ 0.1uF																																			
	≤ 5%	0402 ≥ 33nF, 0603 ≥ 0.15uF, 0805 ≥ 0.68uF, 1206 ≥ 2.2uF, 1210 ≥ 4.7uF,																																			
16V	≤ 10%	0603 ≥ 0.68uF, 0805 ≥ 2.2uF, 1206 ≥ 4.7uF, 1210 ≥ 22uF,																																			
	≤ 10%	0402 & 0603 ≥ 0.33uF, 0805 ≥ 2.2uF, 1206 ≥ 2.2uF, 1210 ≥ 22uF																																			
Vr	D.F	Exception o .F.																																			
≥ 50V	≤ 7%	0603 ≥ 0.1uF, 0805 ≥ 0.47uF, 1206 ≥ 4.7uF																																			
25V	≤ 9%	0402 ≥ 47nF, 0805 ≥ 0.47uF																																			
	≤ 12.5%	121 /10uF																																			
16V	≤ 9%	0402 ≥ 0.068uF, 0603 ≥ 0.68uF																																			
3	Insulation Resistance	<p>Rated voltage ≤ 100V : Apply RV for 120 sec.</p> <p>Rated voltage 200-630V : Apply RV for 60 sec.</p> <p>Rated voltage 1KV-6KV : Apply 500V fo 60 sec.</p>	<p><b>NPO : ≥ 100GΩ or 1000ΩF (whichever is smaller)</b></p> <p><b>X7R/X5R, Y5V : ≥ 10GΩ or 500Ω-F(whichever is smaller)</b></p>																																		
	Dielectric Strength	<p>Test voltage(Vt): (Duration 1~5 seconds.)</p> <p>Vt= Vr X250% (Vr ≤ 100V) Charge current: ≤ 50mA</p> <p>Vt= Vr X200% For product Vr=200V/250V</p> <p>Vt= Vr X150% For product Vr=500V~999V</p> <p>Vt= Vr X120% For product Vr=1KV~3KV</p> <p>Vt= Vr X110% For Vr ≤ 5KV, Vt= Vr X100% For Vr &gt; 5KV</p>	<p>No evidence of damage or flash over d ring test.</p>																																		
5	Solderability	<p>*Solder temperature : 235±5°C</p> <p>*Dipping time : 2±0.5 sec.</p>	<p>95% min. c verage of all metalized area</p>																																		

## SPECIFICATIONS AND TEST METHODS

No	Item	Test Method	Specification				
6	Vibration Resistance	<p>*Vibration Frequency: 10 – 55 Hz.min.</p> <p>*Total amplitude: 1.5mm</p> <p>*Test Time: 6 hrs ( Two hrs each in three mutually perpendicular direction )</p>	<p>No remarkable damage</p> <p>Cap. Change and Q/D.F.: To meet initial spec.</p>				
7	Resistance to Soldering Heat	<p>Preheat the capacitor at 120~150°C for 1min. Have the capacitor dip into the solder bath at 270±5°C for 10±1 sec. Set it at room temperature for 48±4hrs, then measure.</p> <p>■ Initial measurement for X7R/X5R and Y5V. Perform a heat treatment at 150±5°C for 1 hr and then set for 48±4 hrs at room temperature then measure.</p>	Dielectric	NPO	X7R/X5R	Y5V	
			Appearance	No defect			
			Capacitance change	<±2.5% or±0.25 pf	±7.5%	±20%	
			DF( or Q)	C ≥ 30pf : Q ≥ 1000 C < 30pf : Q ≥ 4 0+20C	Same as no.2	Same as no.2	
			I.R	More than 10GΩ or 500ΩF (Whichever is Smaller)			
8	Adhesive Strength of Termination	<p>*Pressurizing force: 5N(≤0603) and 10n(&gt;0603)</p> <p>*Test time: 10 ± 1 sec.</p>	No remarkable damage or removal of the termination.				
			Dielectric	N O	X7R/X R	Y5V	
9	High temperature Load	<p>*Test Temp. : NPO, X7R : 125±3°C X5R, Y5V : 85±3°C</p> <p>*Test Voltage: (1) V &lt; 500V : 2 X R.V. (2) 500 ≤ V &lt; 1000V : 1.5 X R.V. (3) V = 1000V ~ 3000V : 1.2 X R.V. (4) V &gt; 3000V : 100% of R.V.</p> <p>*Test Time: 1000 hrs</p> <p>*Measurement to be made after keeping at room temp. for 48± hr.</p>	Appearance	No defect			
			Capacitance change	<±3% or±0.3 pF whichever is larger	≥ 10V: ±12.5% 6.3V : ±25%	±30%	
			DF( or Q)	SAME AS NO. 2			
			I.R.	≥ 10V, ≥ 1GΩ or 50Ω-F (whichever is smaller) 6.3V: ≥ 10Ω-F			
			Dielectric strength	No failure			

## SPECIFICATIONS AND TEST METHODS

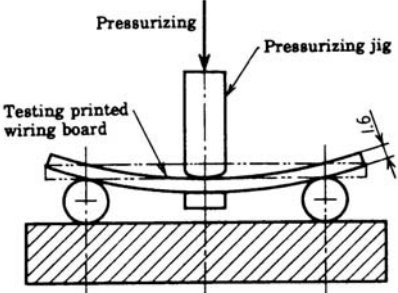
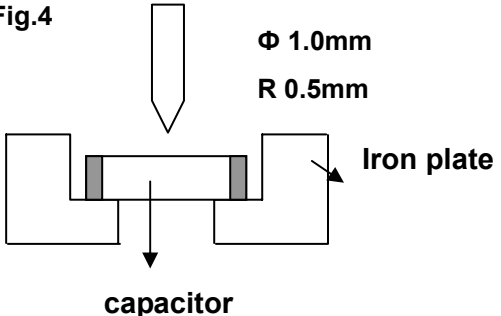
No	Item	Test Method	Specification														
10	Temperature Coefficient	<p>(a) NPO The temperature coefficient is determined using the capacitance measured in step 3 as a reference. When cycling the temperature sequentially from step 1 through 5. The capacitance shall be within the specified tolerance for the temperature coefficient.</p> <table border="1" style="margin: 10px auto; border-collapse: collapse;"> <thead> <tr> <th style="width: 10%;">Step</th> <th style="width: 90%;">Temperature(°C)</th> </tr> </thead> <tbody> <tr> <td style="text-align: center;">1</td> <td style="text-align: center;">+25±2°C</td> </tr> <tr> <td style="text-align: center;">2</td> <td style="text-align: center;">-55±3°C</td> </tr> <tr> <td style="text-align: center;">3</td> <td style="text-align: center;">+25±2°C</td> </tr> <tr> <td style="text-align: center;">4</td> <td style="text-align: center;">+125±3°C(for NPO/X7R +85 ± 3°C(for X5R/Y5V))</td> </tr> <tr> <td style="text-align: center;">5</td> <td style="text-align: center;">+25±2°C</td> </tr> </tbody> </table> <p>(b) X7R/X5R,Y5V The ranges of capacitance change compared with the 25±2°C value over the temperature range shall be within the specified ranges</p>	Step	Temperature(°C)	1	+25±2°C	2	-55±3°C	3	+25±2°C	4	+125±3°C(for NPO/X7R +85 ± 3°C(for X5R/Y5V))	5	+25±2°C	Dielectric	Temperature Range	Capacitance Change
			Step	Temperature(°C)													
			1	+25±2°C													
			2	-55±3°C													
3	+25±2°C																
4	+125±3°C(for NPO/X7R +85 ± 3°C(for X5R/Y5V))																
5	+25±2°C																
NPO	-55°C to +125°C	0±30ppm/°C															
X7R	-55°C to +125°C	Within ±15%															
X5R	-55°C to +85°C	Within ±15%															
Y5V	-25°C to +85°C	Within  +30%~-80%															
11	Resistance to board bending	<p>Mount the capacitor to the testing printed wiring board. Then apply force in the direction shown in Fig.3. The bending stroke shall be more than 1mm, Pressurizing is carried out at the rate of 1mm/s. After reaching the specified bending, keeping it for 5±1 seconds then measure the capacitance value.</p> <p>Cap. Change : NPO: ±5% or ±0.5 pF whichever is larger X7R, X5R: ±12.5% Y5V: ±30%</p> <p>( This capacitance change means the change of capacitance under specified flexure of substrate from the capacitance measured before the test )</p>	<p>No cracking or marking defects shall occur Fig.3</p> <p style="text-align: right;">Unit: mm</p> 														
12	Chip Break Strength	<p>Place the capacitor on an iron plate, And then gradually apply a load on the center of the chip until it breaks.</p> <p>Tip of push-pull gauge is shown in Fig.4</p>	<p>To load 2 kgf at least.</p> <p>Fig.4</p> 														

## SPECIFICATIONS AND TEST METHODS

No	Item	Test Method	Specification																												
13	Temperature cycle	<p>Mount the capacitor on test board, then cycling the temperature sequentially from step 1 to step 5, and perform 25 cycles.</p> <table border="1" style="width: 100%; border-collapse: collapse;"> <thead> <tr> <th style="text-align: center;">Step.</th> <th style="text-align: center;">NPO</th> <th style="text-align: center;">X7R</th> <th style="text-align: center;">X5R/Y5V</th> </tr> </thead> <tbody> <tr> <td></td> <td colspan="2" style="text-align: center;">Temperature (°C ) /time(min)</td> <td style="text-align: center;">Temperature(°C ) /time(min)</td> </tr> <tr> <td style="text-align: center;">1</td> <td colspan="2" style="text-align: center;">+25±2°C / 3±1</td> <td style="text-align: center;">+25±2°C / 3±1</td> </tr> <tr> <td style="text-align: center;">2</td> <td colspan="2" style="text-align: center;">-55±2°C / 30±3</td> <td style="text-align: center;">-30±2°C / 30±3</td> </tr> <tr> <td style="text-align: center;">3</td> <td colspan="2" style="text-align: center;">+25±2°C / 3±1</td> <td style="text-align: center;">+25±2°C / 3±1</td> </tr> <tr> <td style="text-align: center;">4</td> <td colspan="2" style="text-align: center;">+125±3°C / 30±3</td> <td style="text-align: center;">+85±3°C / 30±3</td> </tr> <tr> <td style="text-align: center;">5</td> <td colspan="2" style="text-align: center;">+25±2°C / 3±1</td> <td style="text-align: center;">+25±2°C / 3±1</td> </tr> </tbody> </table> <p>Remove and let sit for 24±2hours(NPO) or 48±4hours(X7R/X5R,Y5V) at room temperature, then measure</p>	Step.	NPO	X7R	X5R/Y5V		Temperature (°C ) /time(min)		Temperature(°C ) /time(min)	1	+25±2°C / 3±1		+25±2°C / 3±1	2	-55±2°C / 30±3		-30±2°C / 30±3	3	+25±2°C / 3±1		+25±2°C / 3±1	4	+125±3°C / 30±3		+85±3°C / 30±3	5	+25±2°C / 3±1		+25±2°C / 3±1	<p>*No remarkable damage.</p> <p>*Cap. Change : NPO: ±2.5% or ±0.5 pF whichever is larger</p> <p>X7R, X5R: ±7.5%</p> <p>Y5V: ±20%</p> <p>*Q/D.F..I.R &amp; dielectric strength : To meet initial requirement.</p>
Step.	NPO	X7R	X5R/Y5V																												
	Temperature (°C ) /time(min)		Temperature(°C ) /time(min)																												
1	+25±2°C / 3±1		+25±2°C / 3±1																												
2	-55±2°C / 30±3		-30±2°C / 30±3																												
3	+25±2°C / 3±1		+25±2°C / 3±1																												
4	+125±3°C / 30±3		+85±3°C / 30±3																												
5	+25±2°C / 3±1		+25±2°C / 3±1																												
14	Humidity ( Damp Heat) Steady State	<p>*Test temp.: 40±2°C</p> <p>*Humidity: 90~95% RH</p> <p>*Test time: 500 hrs</p> <p>*Measurement to be made after keeping at room temperature for 48±4 hrs. EXCEPTION OF D.F.</p> <p>X7R/X5R:</p> <table border="1" style="width: 100%; border-collapse: collapse;"> <thead> <tr> <th style="text-align: center;">Vr</th> <th style="text-align: center;">D.F</th> <th style="text-align: center;">Exception of D.F.</th> </tr> </thead> <tbody> <tr> <td style="text-align: center;">≥ 50V</td> <td style="text-align: center;">≤ 6%</td> <td style="text-align: center;">0603 ≥ 47nF, 0805 ≥ 0.18uF, 1206 ≥ 0.47uF, 1210 ≥ 1.0uF</td> </tr> <tr> <td style="text-align: center;">25V</td> <td style="text-align: center;">≤ 10% ≤ 14%</td> <td style="text-align: center;">0805 ≥ 1.0uF, C ≥ 4.7uF 0603 ≥ 0.33uF</td> </tr> <tr> <td style="text-align: center;">16V</td> <td style="text-align: center;">≤ 10%</td> <td style="text-align: center;">0402 ≥ 33nF, 0603 ≥ 0.15uF 0805 ≥ 0.68uF, C ≥ 2.2uF</td> </tr> <tr> <td style="text-align: center;">10V</td> <td style="text-align: center;">≤ 15%</td> <td style="text-align: center;">0402 ≥ 56nF, 0603 ≥ 0.33uF C ≥ 2.2uF</td> </tr> </tbody> </table> <p>Y5V:</p> <table border="1" style="width: 100%; border-collapse: collapse;"> <thead> <tr> <th style="text-align: center;">Vr</th> <th style="text-align: center;">D.F</th> <th style="text-align: center;">Exception of D.F.</th> </tr> </thead> <tbody> <tr> <td style="text-align: center;">25V</td> <td style="text-align: center;">≤ 10% ≤ 12.5%</td> <td style="text-align: center;">0603 ≥ 0.1uF, 0805 ≥ 0.33uF 1206 ≥ 1.0 uF 0402 ≥ 0.047uF</td> </tr> </tbody> </table>	Vr	D.F	Exception of D.F.	≥ 50V	≤ 6%	0603 ≥ 47nF, 0805 ≥ 0.18uF, 1206 ≥ 0.47uF, 1210 ≥ 1.0uF	25V	≤ 10% ≤ 14%	0805 ≥ 1.0uF, C ≥ 4.7uF 0603 ≥ 0.33uF	16V	≤ 10%	0402 ≥ 33nF, 0603 ≥ 0.15uF 0805 ≥ 0.68uF, C ≥ 2.2uF	10V	≤ 15%	0402 ≥ 56nF, 0603 ≥ 0.33uF C ≥ 2.2uF	Vr	D.F	Exception of D.F.	25V	≤ 10% ≤ 12.5%	0603 ≥ 0.1uF, 0805 ≥ 0.33uF 1206 ≥ 1.0 uF 0402 ≥ 0.047uF	<p>*No remarkable damage</p> <p>*Cap. Change : NPO: ±5% or ±0.5 pF whichever is larger X7R/X5R: ≥ 10V: ±12.5%, 6.3V : ±25% Y5V: ±30%</p> <p>*Q value/D.F. NPO : C ≥ 30pf : Q ≥ 350 10pF ≤ Cap &lt; 30pF, Q ≥ 275+2.5C Cap &lt; 10pF, Q ≥ 200+10C X7R, X5R : Vr ≥ 50V, D.F. ≤ 3% Vr=16/25V, D.F. ≤ 5% Vr=10V, D.F. ≤ 7.5% Y5V : Vr ≥ 25/50V, D.F. ≤ 7.5% Vr=16V(C &lt; 1.0uF), DF ≤ 10% Vr=16V(C ≥ 1.0uF), DF ≤ 12.5% Vr=10V, D.F. ≤ 15% Vr=6.3V, D.F. ≤ 30% <b>(See EXCEPTION at left side)</b></p> <p>≥ 10V, ≥ 1GΩ or 50Ω-F (whichever is smaller) 6.3V: ≥ 10Ω-F</p>							
Vr	D.F	Exception of D.F.																													
≥ 50V	≤ 6%	0603 ≥ 47nF, 0805 ≥ 0.18uF, 1206 ≥ 0.47uF, 1210 ≥ 1.0uF																													
25V	≤ 10% ≤ 14%	0805 ≥ 1.0uF, C ≥ 4.7uF 0603 ≥ 0.33uF																													
16V	≤ 10%	0402 ≥ 33nF, 0603 ≥ 0.15uF 0805 ≥ 0.68uF, C ≥ 2.2uF																													
10V	≤ 15%	0402 ≥ 56nF, 0603 ≥ 0.33uF C ≥ 2.2uF																													
Vr	D.F	Exception of D.F.																													
25V	≤ 10% ≤ 12.5%	0603 ≥ 0.1uF, 0805 ≥ 0.33uF 1206 ≥ 1.0 uF 0402 ≥ 0.047uF																													
14	Humidity (Damp Heat) Load	<p>*Test temp.: 40±2°C</p> <p>*Humidity: 90~95% RH</p> <p>*Test time: 500 hrs</p> <p>*Test Voltage : Rated Voltage ( Max 500V)</p> <p>*Measurement to be made after keeping at room temperature for 48±4 hrs.</p>	<p>*No remarkable damage</p> <p>*Cap. Change : NPO: ±7.5% or ±0.75 pF whichever is larger X7R/X5R: ≥ 10V: ±12.5%, 6.3V : ±25% Y5V: ±30%</p> <p>*Q value/D.F. <b>SAME AS No. 13</b></p>																												



## 2. Packing

8-1. Bulk Packaging: Packing code(B)

8-2. Tape Packaging: please specify the packing code when ordering.

Packing code	Pcs/Reel	Reel size	
05	500	7"	
1	1000	7"	
2	2000	7"	
3	3000	7"	
T	4000	7"	
U	10000	0402	7"
		0603	10"
V	15000	13"	
W	20000	13"	

### 8-3. Appearance of taping

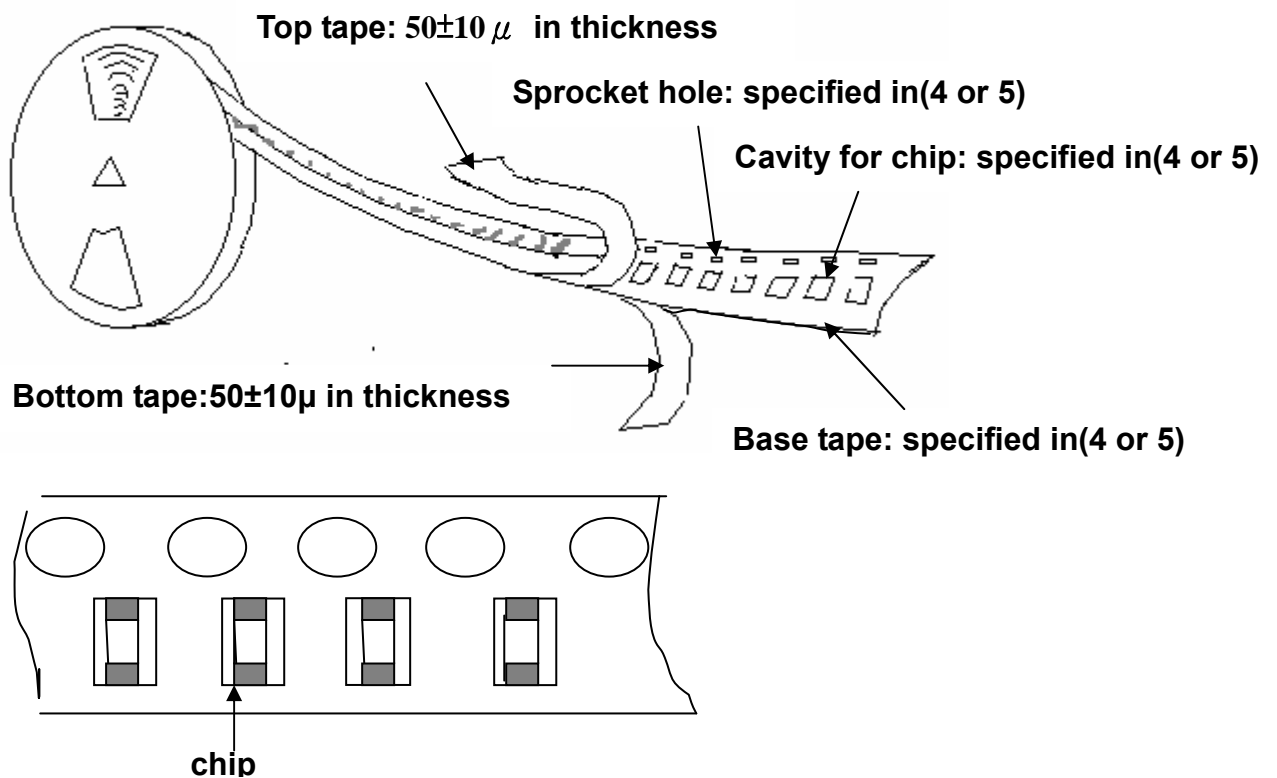

## 8-4 Dimensions of Paper Tape

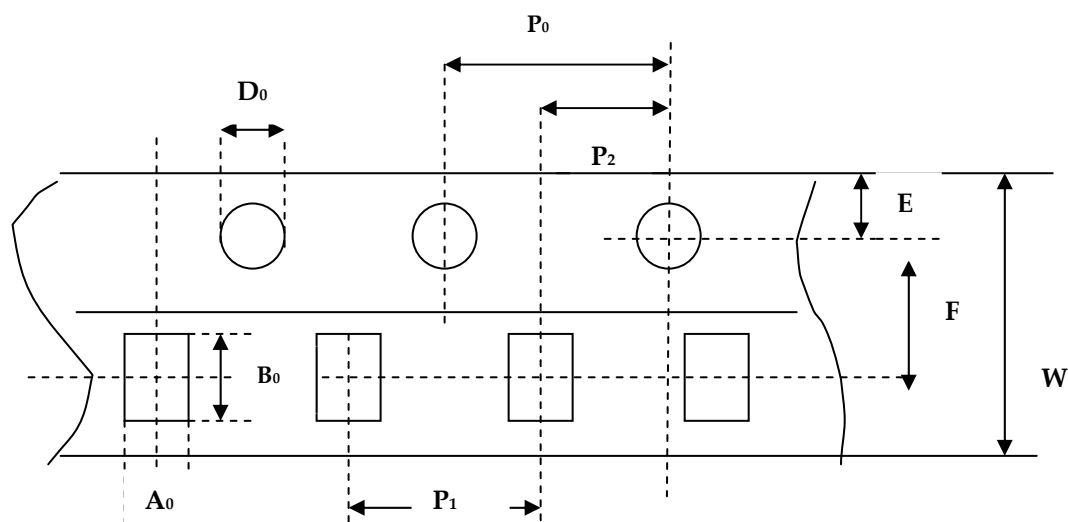

Unit: m/m

Chip size	0402	0603	0805	1206	Tolerance
<b>Mark</b>					
<b>A<sub>0</sub></b>	0.61	1.02	1.50	2.00	±0.1
<b>B<sub>0</sub></b>	1.10	1.82	2.30	3.50	±0.1
<b>W</b>	8.0	8.0	8.0	8.0	±0.3
<b>E</b>	1.75	1.75	1.75	1.75	±0.1
<b>F</b>	3.5	3.5	3.5	3.5	±0.05
<b>D<sub>0</sub></b>	1.55	1.55	1.55	1.55	±0.1
<b>P<sub>1</sub></b>	2.0	4.0	4.0	4.0	±0.05
<b>P<sub>2</sub></b>	2.0	2.0	2.0	2.0	±0.05
<b>P<sub>0</sub></b>	4.0	4.0	4.0	4.0	±0.05

**Paper thickness:** T:0.65±0.05 mm (for 0402 product)  
T:0.75±0.05 mm (for thickness code S)  
T:0.95±0.05 mm (for thickness code P, H)

- Note:** (1) The top tape and bottom tape shall not protrude beyond the edges of the tape, and shall not cover sprocket holes.  
(2) Cumulative tolerance of sprocket holes 10 pitch : ±0.3mm

### 8-5 Dimensions of Embossed Packing (plastic tape):

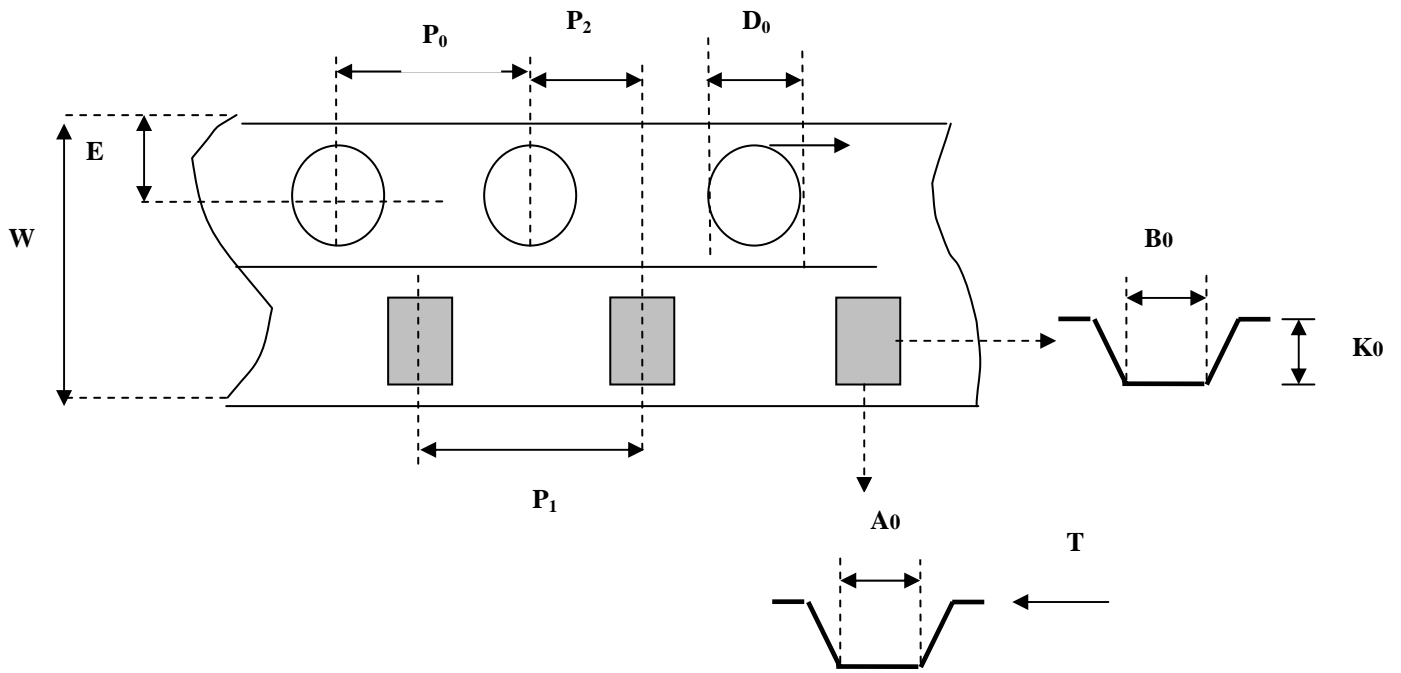

unit: m/m

Chip size / Mark	0805	1206	1210	1808	1812	1825	2220	2211	2225
<b>A<sub>0</sub></b>	1.65±0.2	2.00±0.2	2.80±0.2	2.40±0.2	3.60±0.2	<6.80	5.50±0.3	<3.30	<6.80
<b>B<sub>0</sub></b>	2.40±0.2	3.60±0.2	3.60±0.2	4.90±0.3	4.90±0.3	<5.30	6.20±0.3	<6.50	<6.50
<b>K<sub>0</sub></b>	2.50 max	2.50 max	3.00 max	2.50 max	4.0 max	<3.10	4.0 max	<3.10	<3.10
<b>D<sub>0</sub></b>	1.55±0.1	1.55±0.1	1.55±0.1	1.55±0.1	1.55±0.1	1.50+0.10/-0	1.55±0.1	1.50+0.10/-0	1.50+0.10/-0
<b>W</b>	8.00±0.2	8.0±0.2	8.0±0.2	12.0±0.2	12.0±0.2	12.0±0.20	12.0±0.2	12.0±0.20	12.0±0.20
<b>P<sub>1</sub></b>	4.00±0.1	4.00±0.1	4.00±0.1	4.00±0.1	8.00±0.1	8.00±0.10	8.0±0.1	8.00±0.10	8.00±0.10
<b>P<sub>2</sub></b>	2.00±0.1	2.00±0.1	2.00±0.1	2.00±0.1	2.00±0.1	2.00±0.05	2.0±0.1	2.00±0.05	2.00±0.05
<b>E</b>	1.75±0.1	1.75±0.1	1.75±0.1	1.75±0.1	1.75±0.1	1.75±0.10	1.75±0.1	1.75±0.10	1.75±0.10
<b>T</b>	0.23±0.05	0.23±0.05	0.23±0.05	0.23±0.05	0.25±0.1	0.30±0.10	0.25±0.1	0.30±0.10	0.30±0.10
<b>P<sub>0</sub></b>	4.00±0.1	4.00±0.1	4.00±0.1	4.00±0.1	4.00±0.1	4.00±0.10	4.00±0.1	4.00±0.10	4.00±0.10

Emboss tape: for thickness code X, L, Z, G, N, U

### 8-6. Dimension of Reel.

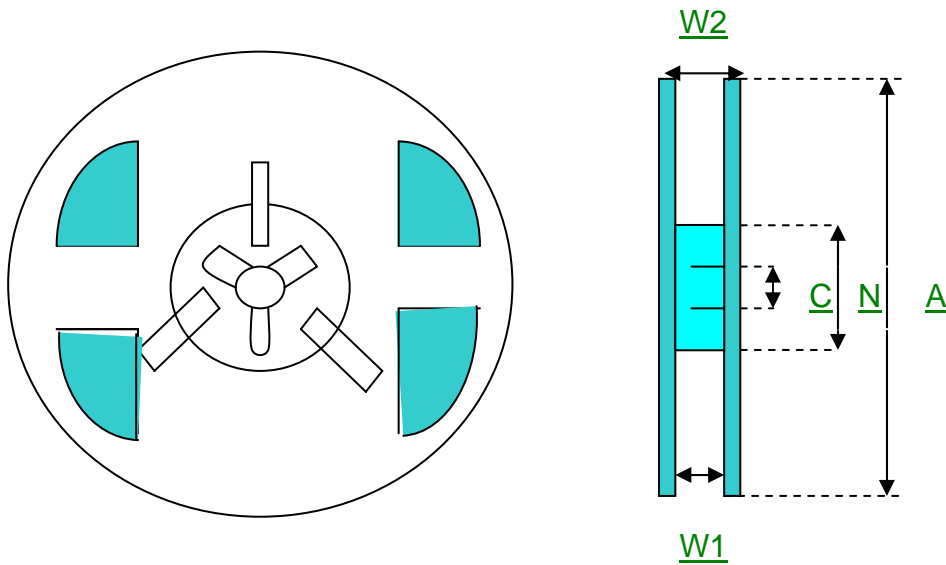

unit: m/m

Reel size	A	N	C	W1	W2(max.)
7" 0402~1210	178 ±0.5	60.5±1.0	13.0+0.5/-0.2	8.4+1.5/-0	14.4
7" 1812~2225	178 ±0.5	60.5±1.0	13.0+0.5/-0.2	12.4+2.0/-0	16.0
10"	250 ±0.5	100 ±1.0	13.0+0.5/-0.2	8.4+1.5/-0	14.4
13"	330 ±0.5	100 ±1.0	13.0+0.5/-0.2	8.4+1.5/-0	14.4

### 3. Soldering & Cleaning

#### Recommended Soldering Profile (Prevention of thermal shock)

Figure.(I) IR reflow soldering profile for SMT process with SnAgCu series solder paste , (lead free type)

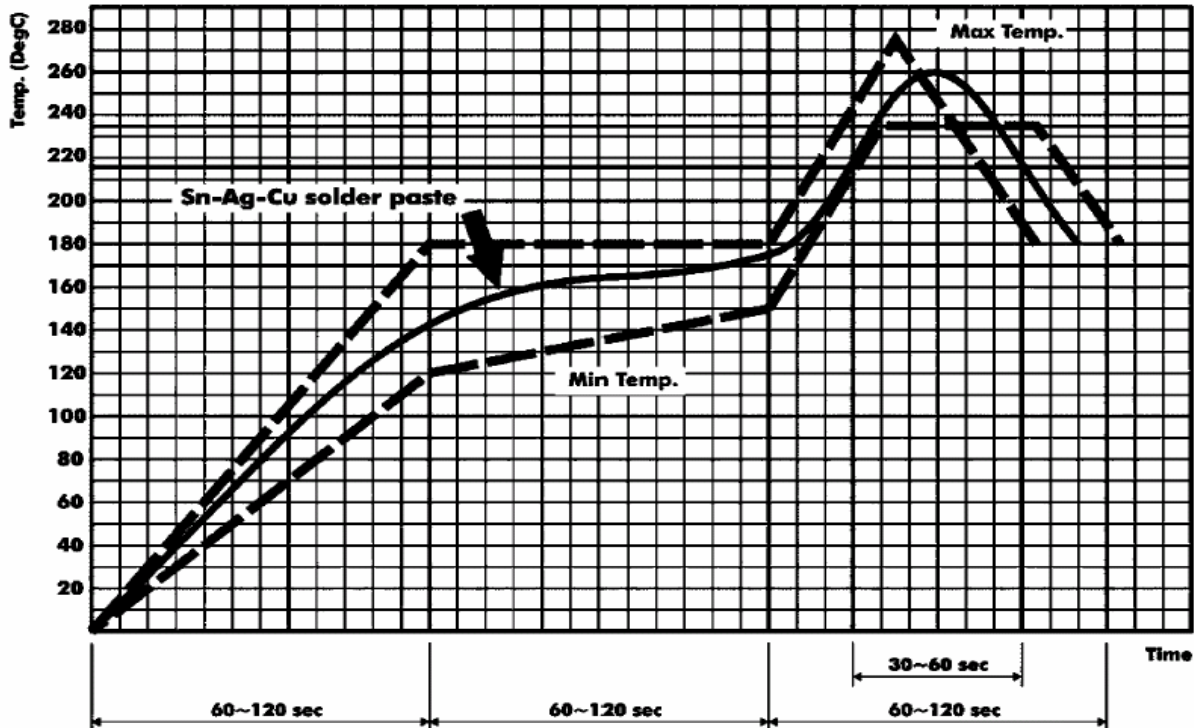
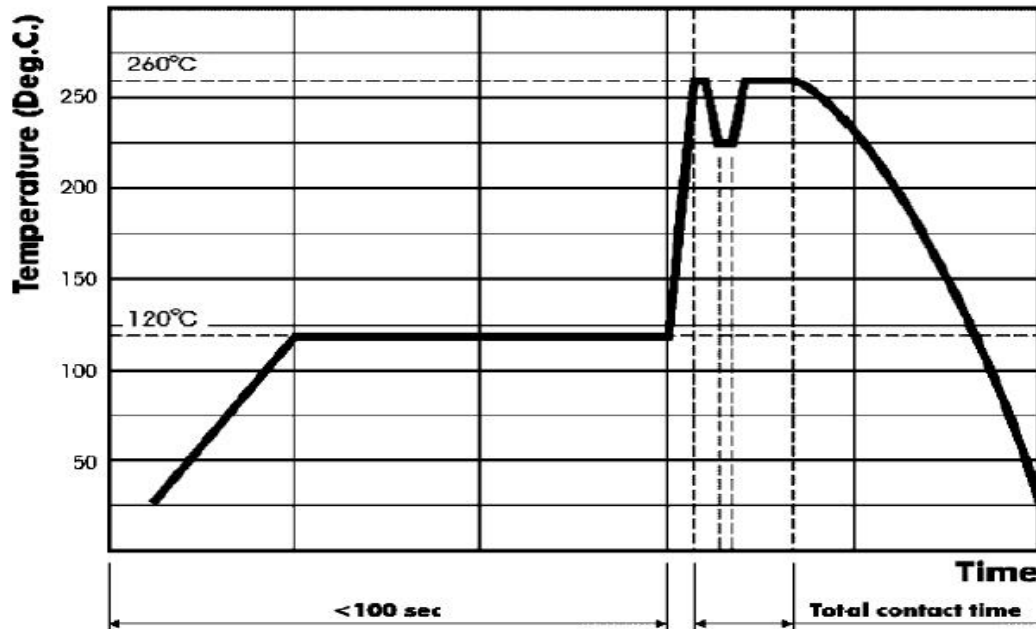

Figure. (II) Wave soldering profile for SMT process with SnAgCu series solder paste, (lead free type)



#### Cleaning :

All flux residues must be removed by using suitable electronic-grade vapor-cleaning solvents to eliminate contamination that could cause electrolytic surface corrosion. Goods results can be obtained by using ultrasonic cleaning of solvent. The choice of the proper system is depends upon many factors such as component mix, flux, and solder paste and assembly method. The ability of the cleaning system to remove flux residues and contamination from under the chips is very important.

## 4. Storage

1. To store products at 5 to 40°C ambient temperature and 20 to 70% related humidity conditions.
2. The product is recommended to be used within one year after shipment. Check solderability in case of shelf life extension is needed.

**Caution:**

- A. Don't store products in a corrosive environment such as sulfide, chloride gas, or acid. It may cause oxidization of electrode, which easily be resulted in poor soldering.
- B. To store products on the shelf and avoid exposure to moisture.
- C. Don't expose products to excessive shock, vibration, direct sunlight and so on.

## 11 Label

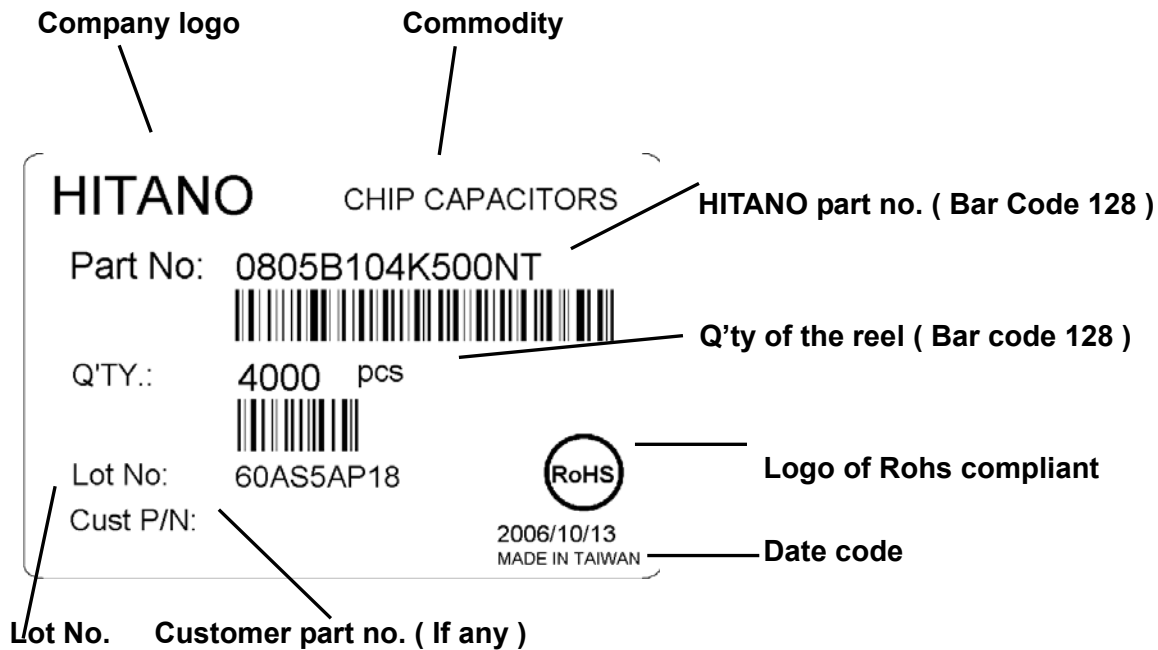

## 12. PCB design

Chip components are susceptible to board stress since the component itself is mounted directly on the board. They are also sensitive to mechanical and thermal stress when solder, which may cause chip cracked.

Please take solder form and component layout into consideration to eliminate stress.

### 12.1. Pattern form

#### (1) Placing of chip components and component.

incorrect

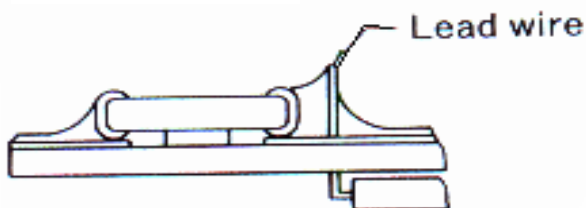

correct

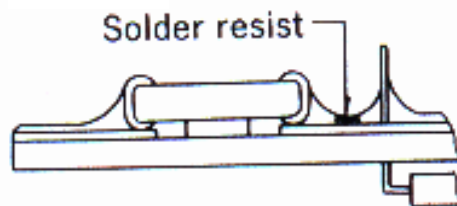

#### (2) Placing close to chassis.

incorrect

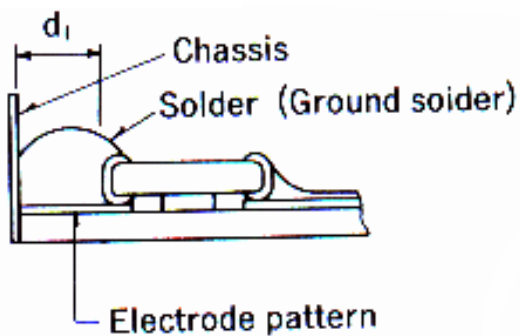

correct

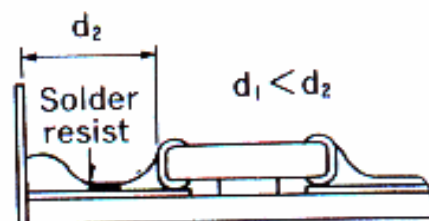

#### (3) Placing leaded components after chip component.

incorrect

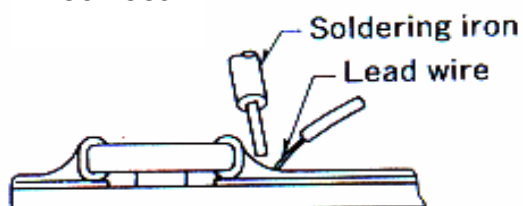

correct

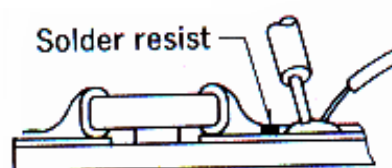

## PCB design

### (4) Lateral mounting

incorrect

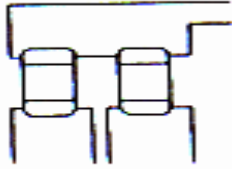

correct

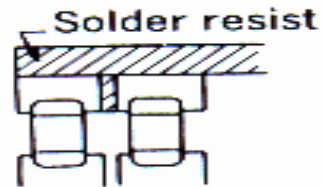

### 12-2. Component direction

To design a mounting position that minimizes the stress imposed on the chip during flexing or bending of the board.

(1) put the component lateral to the direction in which stress acts.

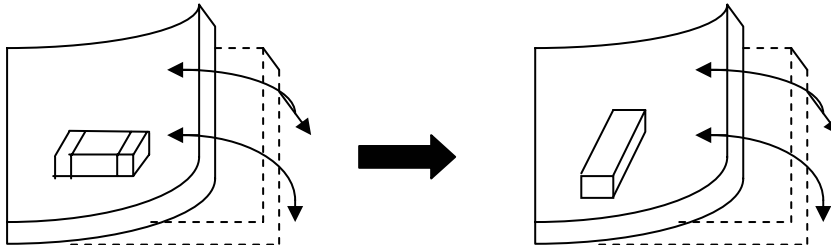

(2) Component layout close to board separation point.  
Susceptibility to stress in the order:  $A > C > B = D$

